

LEP Vinci par navette Ferrières 200203
 LEPA par Clémenceau 200213
 ST JEAN par Alouette 200223 (2 chgts)
 MALABRY par Alouette 200236 200212

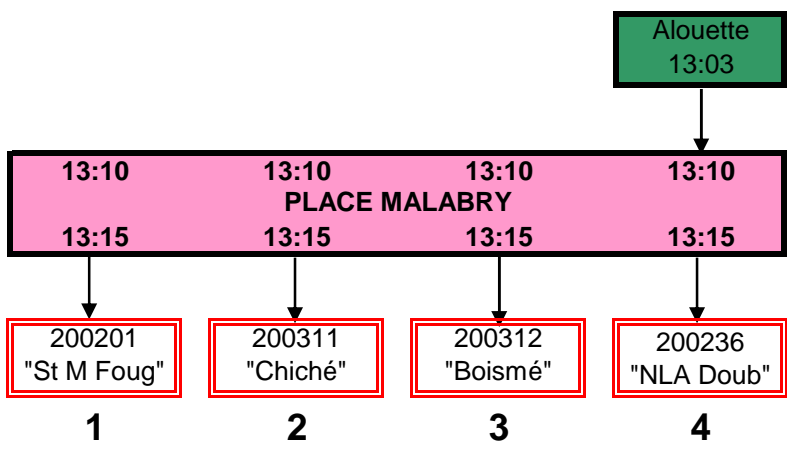

LEP Vinci par navette Ferrières 200205
 LEPA par Gare SNCF 200235 (2 chgts)
 ST JEAN par Alouette 200223 (2 Chgts)
 MALABRY par Alouette 200236

BRESSUIRE
 Desserte directe
 Place Malabry

Matins scolaires

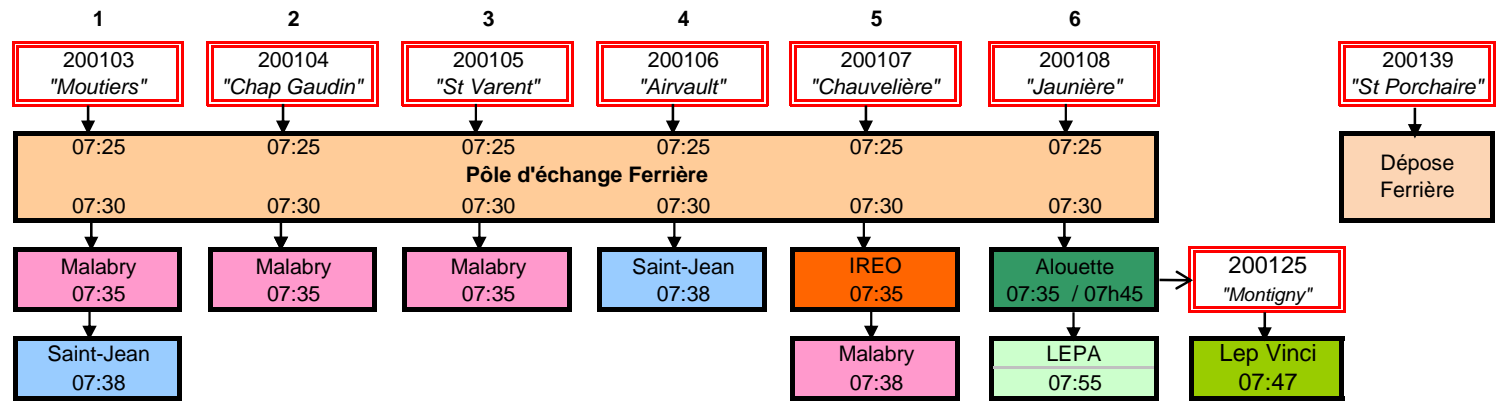

Soirs scolaires

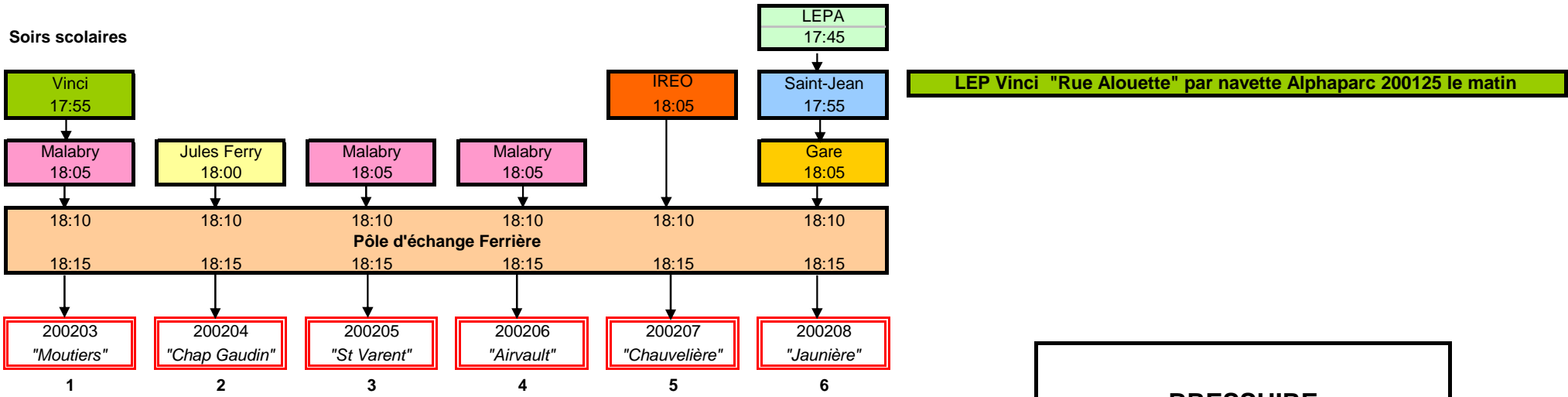

Mercredi milieu de journée

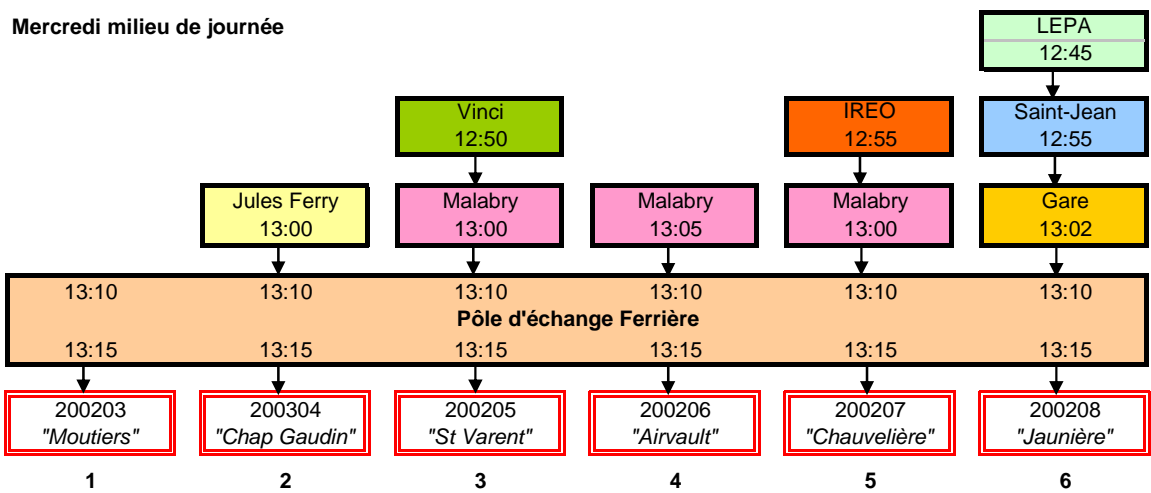

BRESSUIRE
Pôle d'Echanges
Z.A. des Ferrières

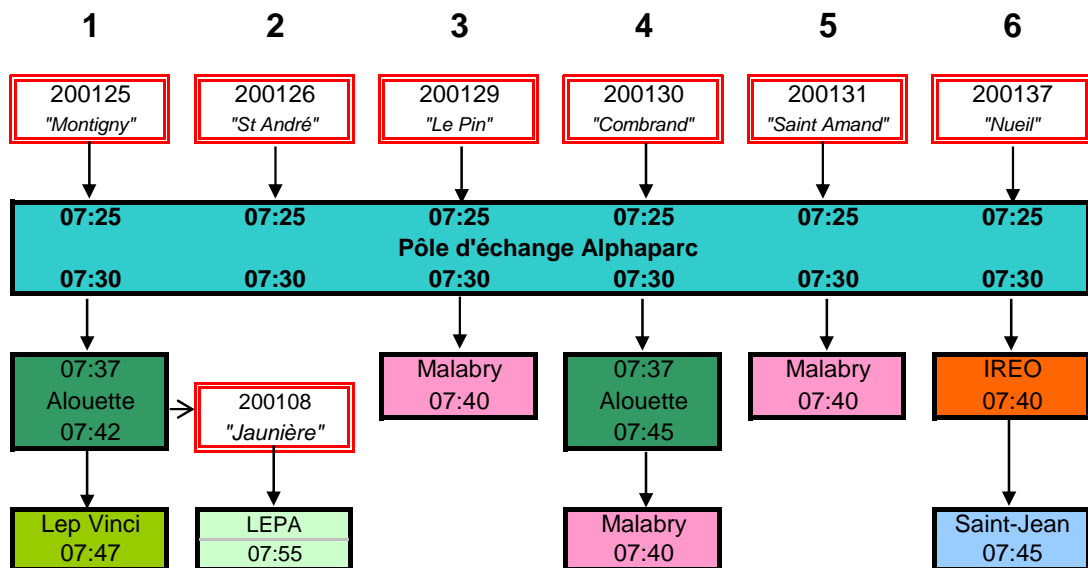

Matins scolaires

LEPA "rue Alouette" par navette Férière 200108

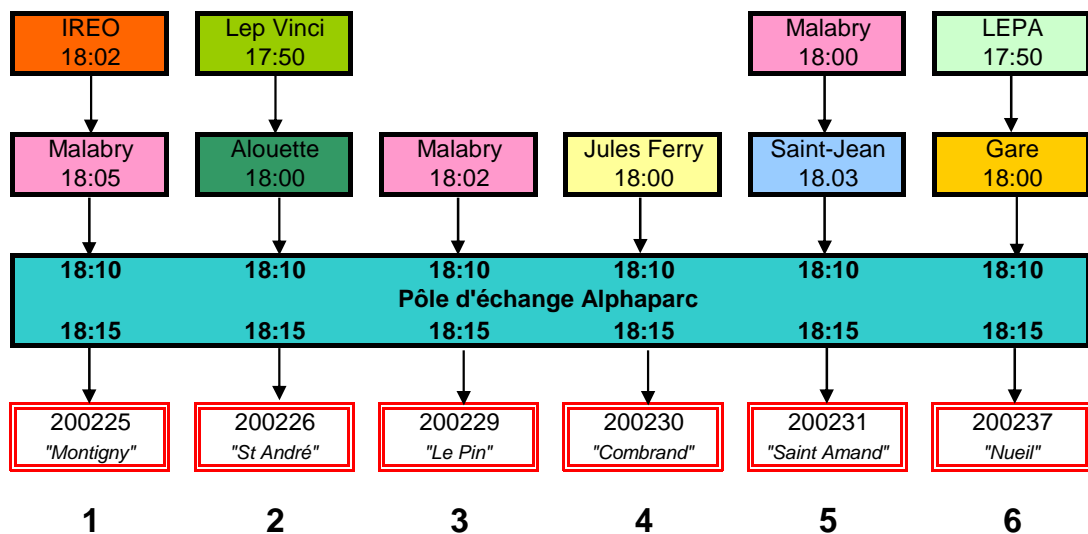

Soirs scolaires

BRESSUIRE
Pôle d'Echanges
Z.A. AlphaParc

Mercredi milieu de journée

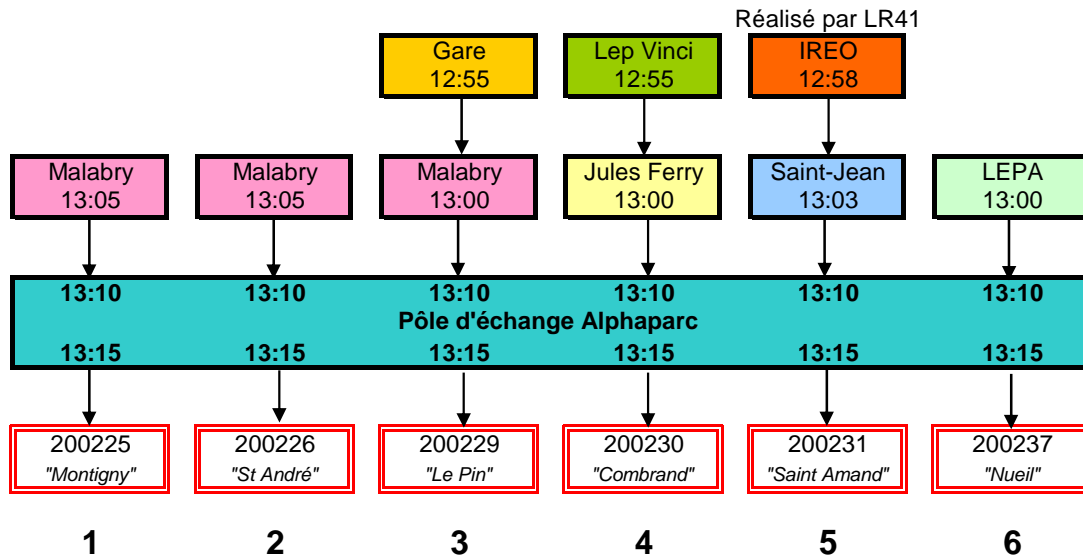

BRESSUIRE
Pôle d'Echanges
Z.A. AlphaParc

Pôle d'échanges CLEMENCEAU

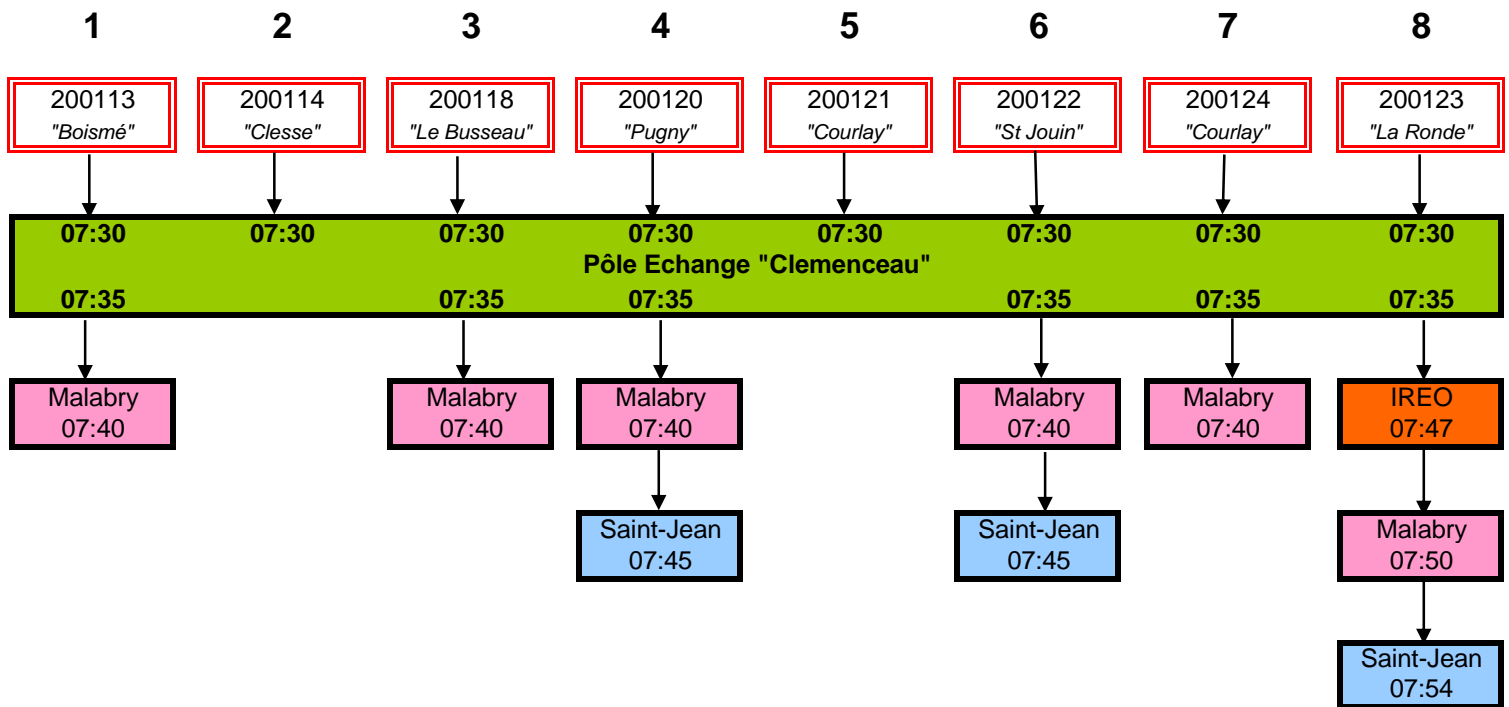

BRESSUIRE
Pôle d'Echanges
Clémenceau / Alouette

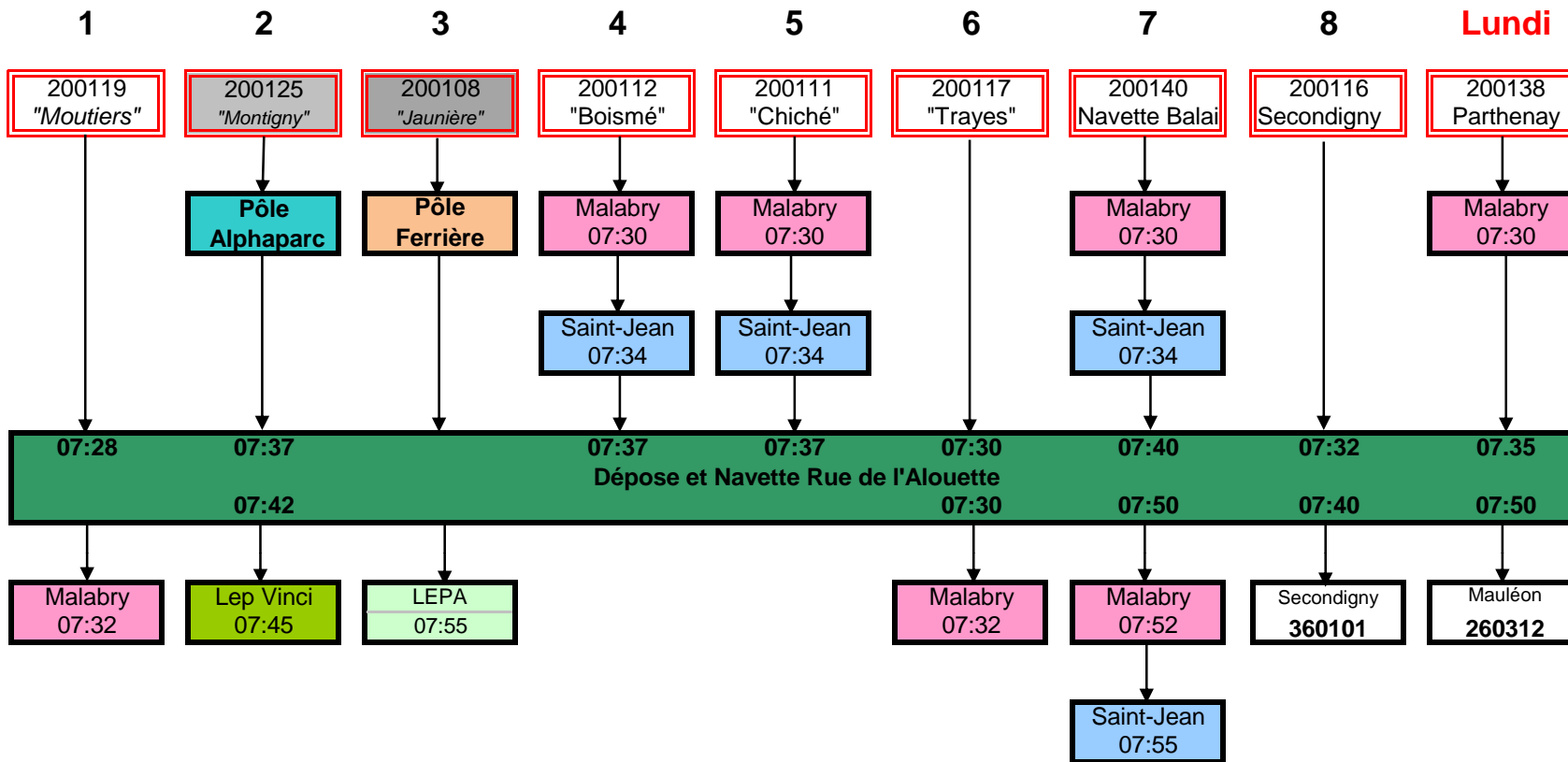

BRESSUIRE
Pôle d'Echanges
Clémenceau / Alouette

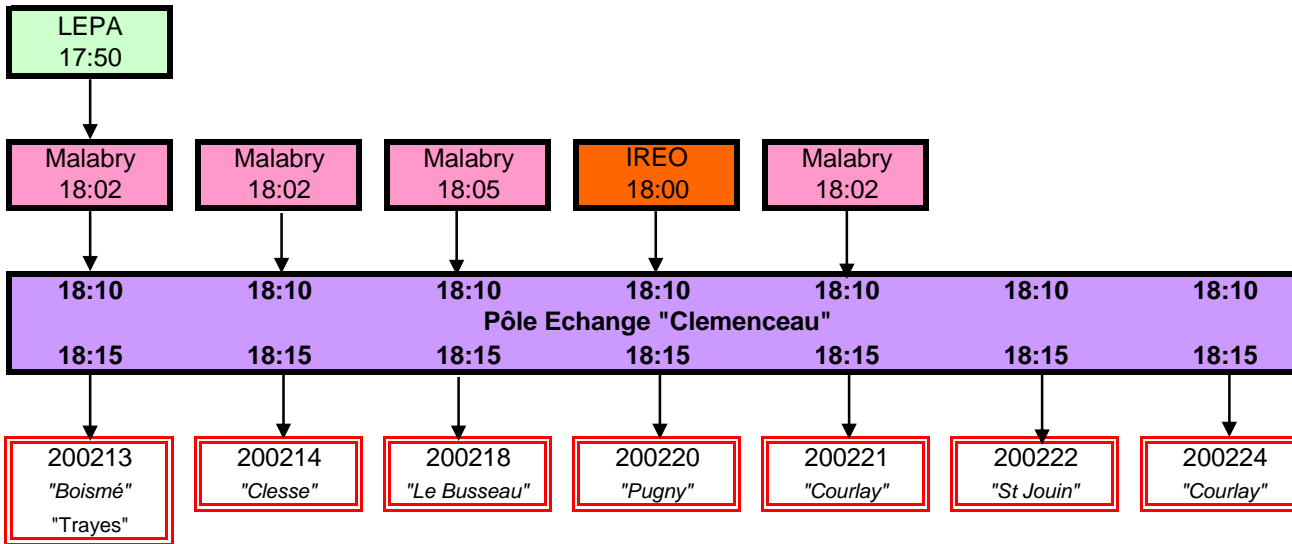

BRESSUIRE
Pôle d'Echanges
Clémenceau / Alouette

Correspondance Moncoutant

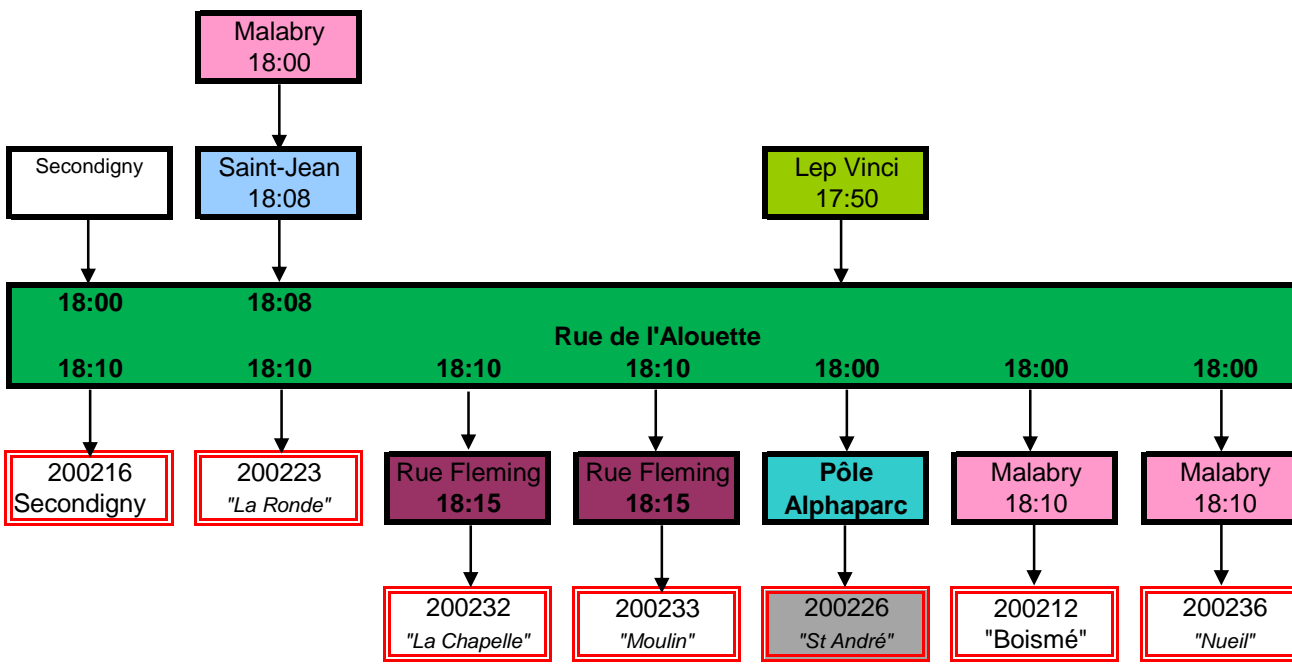

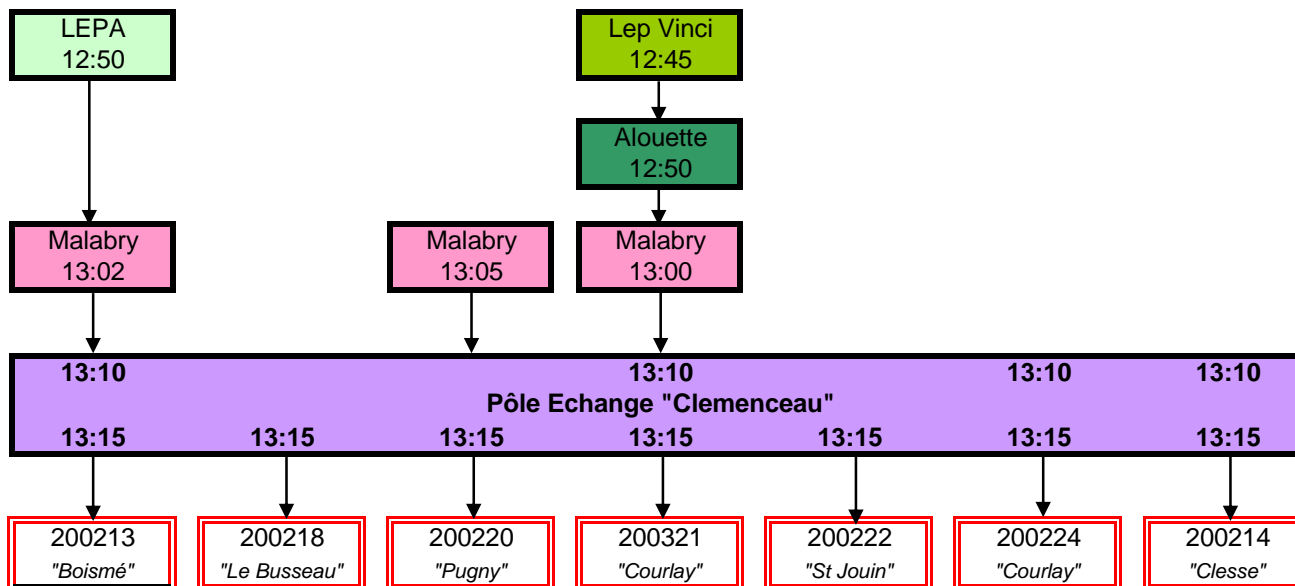

LEPA par gare SNCF
 IREO par Gare SNCF

Correspondance Moncoutant

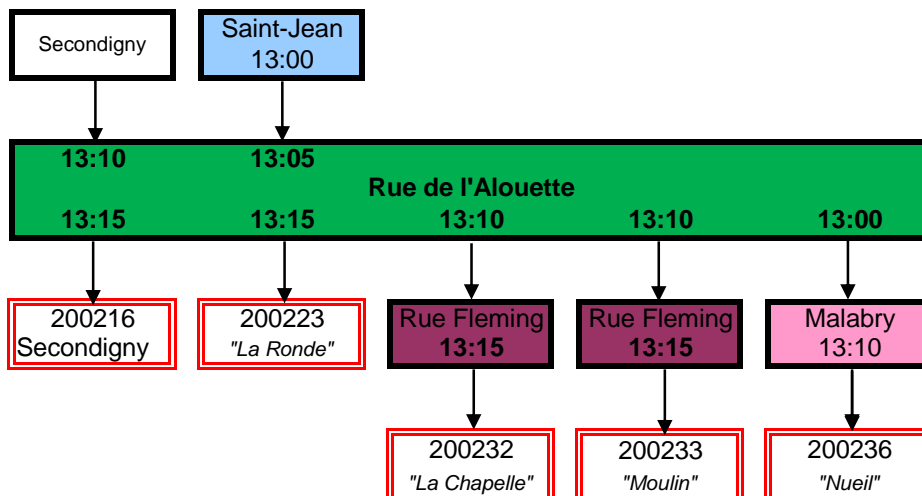
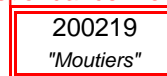

BRESSUIRE
Pôle d'Echanges
Clémenceau / Alouette

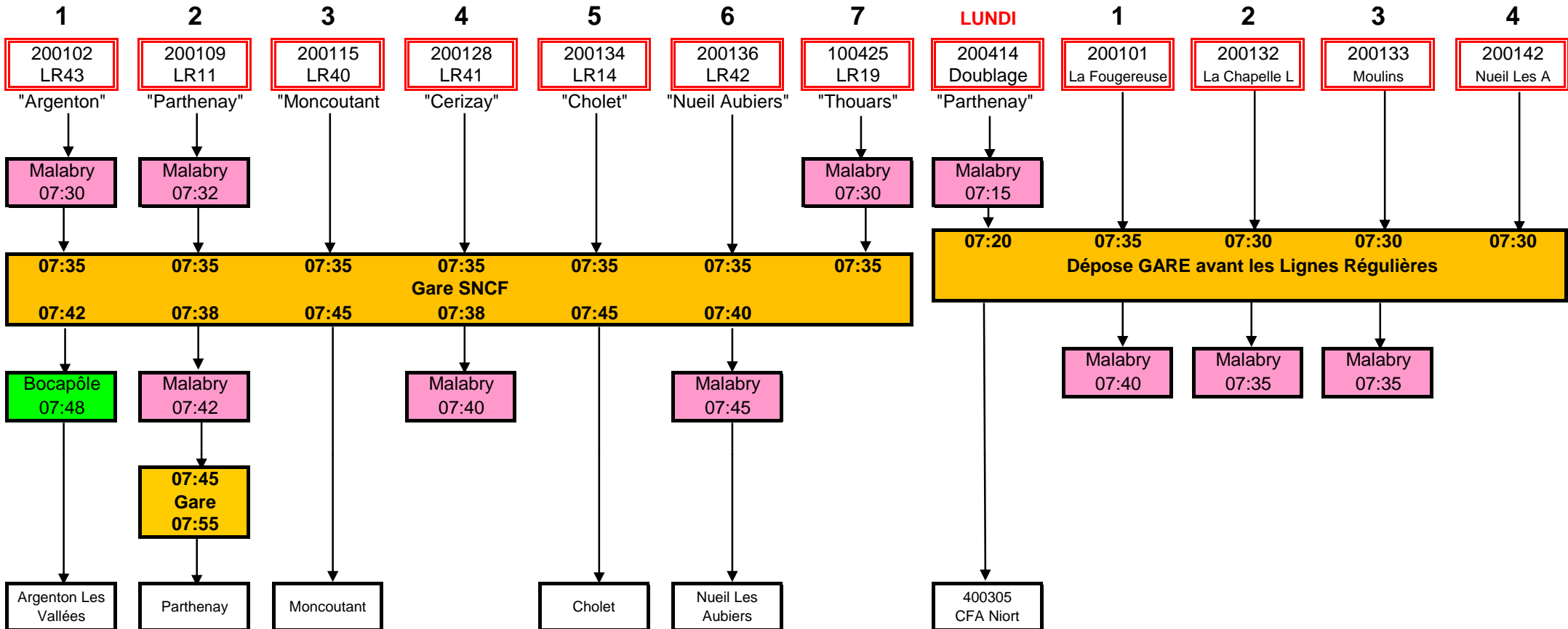

BRESSUIRE
Pôle d'Echanges
Gare SNCF

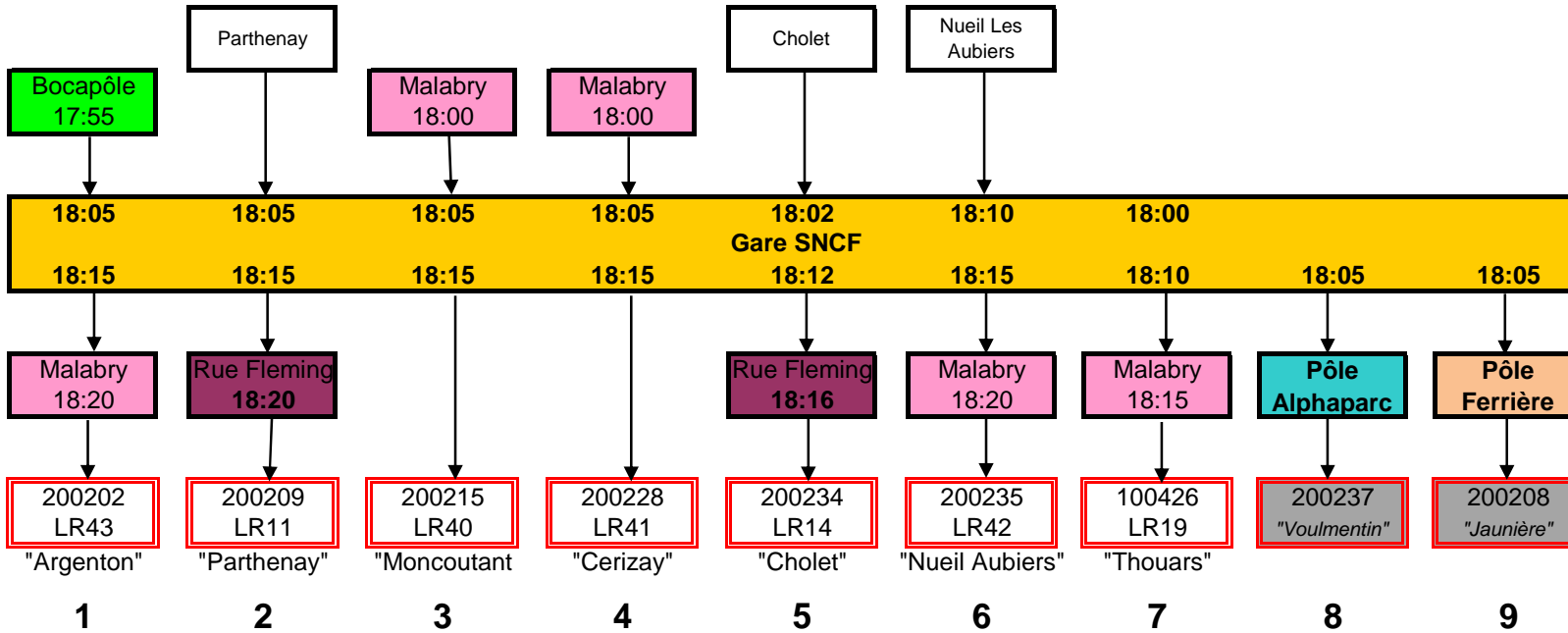

1 2 3 4 5 6 7 8 9

- LEP Vinci par Alouette 200226
- ST JEAN par Alouette 200223
- IRES par Clémenceau 200220

BRESSUIRE
Pôle d'Echanges
Gare SNCF

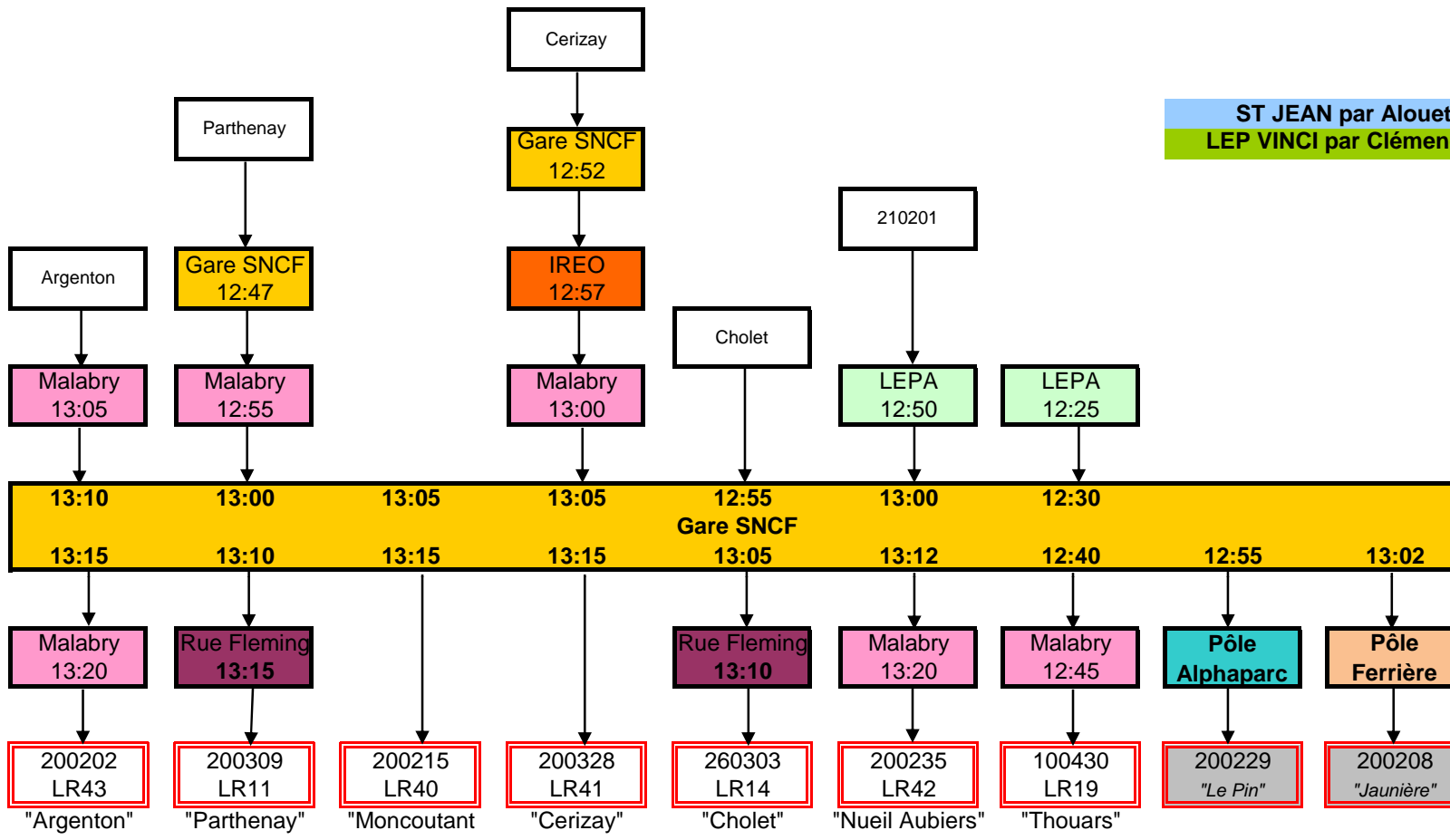

ST JEAN par Alouette 200223
LEP VINCI par Clémenceau 200221

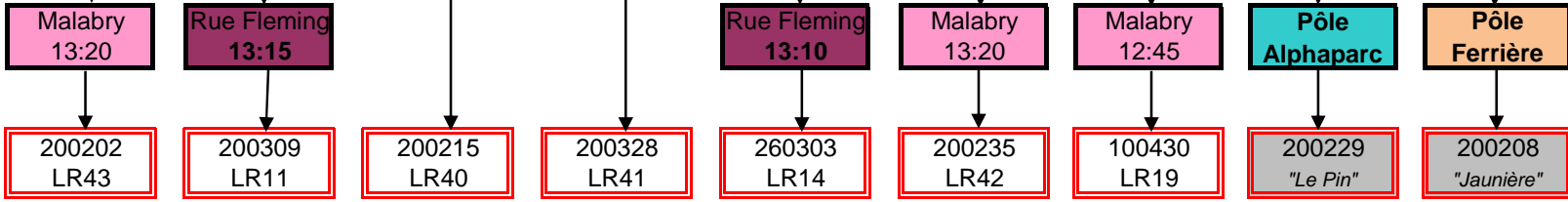

1 2 3 4 5 6 7 8 9

BRESSUIRE
Pôle d'Echanges
Gare SNCF

Retours collèges de Bressuire

	Place Malabry				Arrêt Proche	Place St Jean				Arrêt Proche
210201 Breuil Chaussée Primaire	16h35							16h52		
210202 St Porchaire	16h35					16h40				
210203 Noirterre				16h55					17h00	
210204 Boismé				16h55					17h00	
210205 Clazay Courlay		16h40					16h45			
210206 Chambroutet Noirliou			16h45			16h40				
210207 Moncoutant	16h35					16h40				
210208 Nueil Les Aubiers Beaulieu				16h55		16h35				
210209 St Sauveur Primaire		16h40					16h45			
210210 Cerizay			16h45						Place Laba	16h47
210211 Parthenay			16h45						Gare	16h35
210212 Faye l'Abbesse		16h40				16h40				
210213 Breuil Chaussée	16h35					16h40				
210214 Terves		16h40					16h45			
210215 St Sauveur Public	16h35									
210216 St Porchaire Public	16h35					16h35				
210217 Chiché			16h45					16h50		
210218 Beaulieu Sous Bressuire				16h50		16h35				
210219 Mauléon					Fleming	16h41			Gare	16h35

Nbre véhicules	6	4	4	1	3		3	5	3	2	2
----------------	---	---	---	---	---	--	---	---	---	---	---

